

Direct operated check valves series C5V provide free flow in one direction and block the flow in the counter direction.

The SAE flanges allow to mount the C5V directly on the pressure port of pumps for protection against pressure shocks from the system.

Features

- Direct operated check valve
- SAE61 and SAE62 flange
- 4 sizes (SAE ¾", 1", 1¼", 1½")
- 3 springs
- 5 options for body sealing

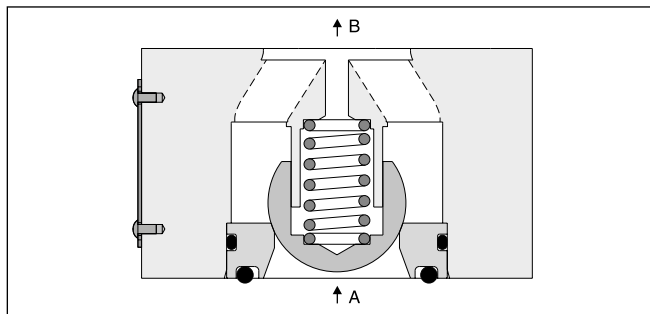
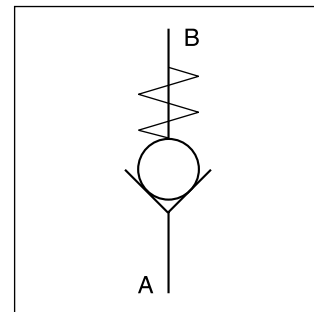

Ordering Code

C5V		-				B																																																	
Direct operated check valve	Nominal size		Flange	Body sealing	Cracking pressure	Design series	Seals	Options																																															
<table border="1" style="width: 100%; border-collapse: collapse;"> <thead> <tr><th>Code</th><th>Port size</th></tr> </thead> <tbody> <tr><td>06</td><td>SAE ¾"</td></tr> <tr><td>08</td><td>SAE 1"</td></tr> <tr><td>10</td><td>SAE 1¼"</td></tr> <tr><td>12</td><td>SAE 1½"</td></tr> </tbody> </table>	Code	Port size	06	SAE ¾"	08	SAE 1"	10	SAE 1¼"	12	SAE 1½"	<table border="1" style="width: 100%; border-collapse: collapse;"> <thead> <tr><th>Code</th><th>Flange</th></tr> </thead> <tbody> <tr><td>3</td><td>SAE61</td></tr> <tr><td>6</td><td>SAE62</td></tr> </tbody> </table>	Code	Flange	3	SAE61	6	SAE62		<table border="1" style="width: 100%; border-collapse: collapse;"> <thead> <tr><th>Code</th><th>Body sealing</th></tr> </thead> <tbody> <tr><td>1</td><td>Sealing for port A</td></tr> <tr><td>2¹⁾</td><td>Sealing for port A and X</td></tr> <tr><td>3</td><td>Without sealing</td></tr> <tr><td>4</td><td>Sealing for port B</td></tr> <tr><td>5</td><td>Sealing for port A and B</td></tr> </tbody> </table>	Code	Body sealing	1	Sealing for port A	2 ¹⁾	Sealing for port A and X	3	Without sealing	4	Sealing for port B	5	Sealing for port A and B	<table border="1" style="width: 100%; border-collapse: collapse;"> <thead> <tr><th>Code</th><th>Cracking pressure</th></tr> </thead> <tbody> <tr><td>0</td><td>0.5 bar</td></tr> <tr><td>1</td><td>1.0 bar</td></tr> <tr><td>2</td><td>2.0 bar</td></tr> </tbody> </table>	Code	Cracking pressure	0	0.5 bar	1	1.0 bar	2	2.0 bar	<table border="1" style="width: 100%; border-collapse: collapse;"> <thead> <tr><th>Code</th><th>Options</th></tr> </thead> <tbody> <tr><td>omit</td><td>Standard</td></tr> <tr><td>019²⁾</td><td>M14 mounting screws</td></tr> </tbody> </table>	Code	Options	omit	Standard	019 ²⁾	M14 mounting screws	<table border="1" style="width: 100%; border-collapse: collapse;"> <thead> <tr><th>Code</th><th>Seals</th></tr> </thead> <tbody> <tr><td>1</td><td>NBR</td></tr> <tr><td>5</td><td>FPM</td></tr> </tbody> </table>	Code	Seals	1	NBR	5	FPM	
Code	Port size																																																						
06	SAE ¾"																																																						
08	SAE 1"																																																						
10	SAE 1¼"																																																						
12	SAE 1½"																																																						
Code	Flange																																																						
3	SAE61																																																						
6	SAE62																																																						
Code	Body sealing																																																						
1	Sealing for port A																																																						
2 ¹⁾	Sealing for port A and X																																																						
3	Without sealing																																																						
4	Sealing for port B																																																						
5	Sealing for port A and B																																																						
Code	Cracking pressure																																																						
0	0.5 bar																																																						
1	1.0 bar																																																						
2	2.0 bar																																																						
Code	Options																																																						
omit	Standard																																																						
019 ²⁾	M14 mounting screws																																																						
Code	Seals																																																						
1	NBR																																																						
5	FPM																																																						

¹⁾ For combination with R5U unloading valve (SAE61 only)

²⁾ Only for C5V10-6 (SAE62)

Technical Data

General						
Size			06 (3/4")	08 (1")	10 (1¼")	12 (1½")
Mounting	2-port inline flange (SAE61 and 62)					
Mounting position	unrestricted					
Ambient temperature	[°C]	-20...+60				
MTTF _D value	[years]	150				
Weight	[kg]	0.6	0.9	1.3	1.8	
Hydraulic						
Max. operating pressure	SAE61	[bar]	350	350	280	210
	SAE62	[bar]	420	420	420	420
Nominal flow	[l/min]	100	200	400	750	
Fluid	Hydraulic oil according to DIN 51524					
Fluid temperature	[°C]	-20...+70 (NBR: -25...+70)				
Viscosity	permitted	[cSt] / [mm ² /s]	20...400			
	recommended	[cSt] / [mm ² /s]	30...80			
Filtration	ISO 4406 (1999); 18/16/13					

C5V06

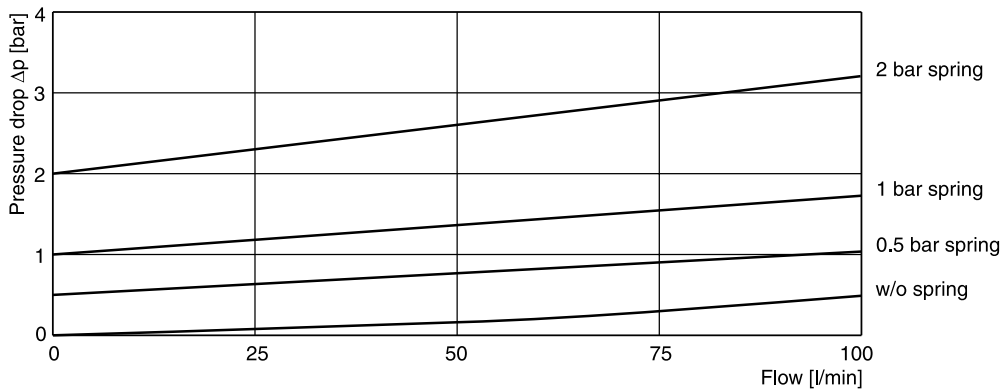

C5V08

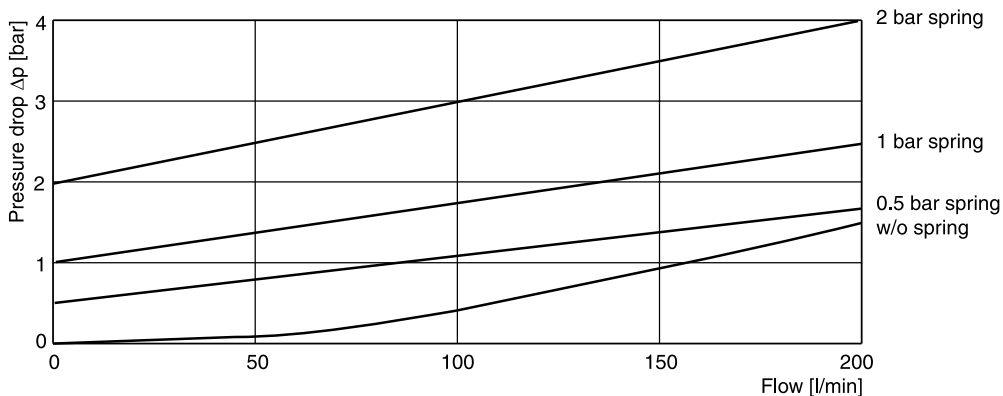

C5V10

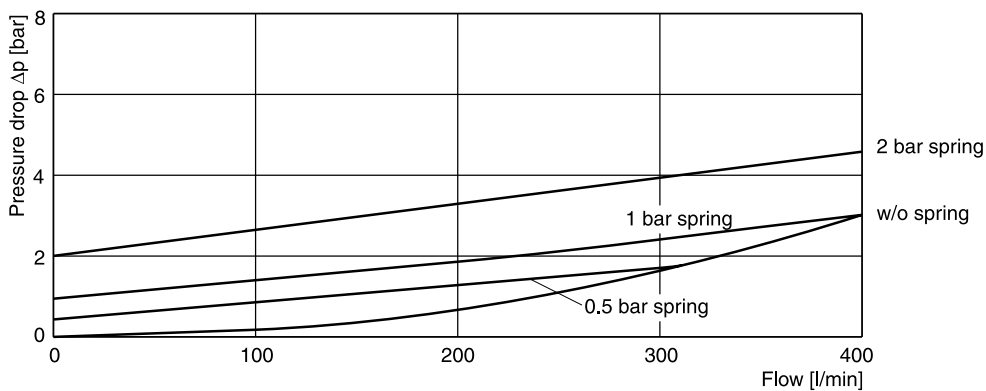

C5V12

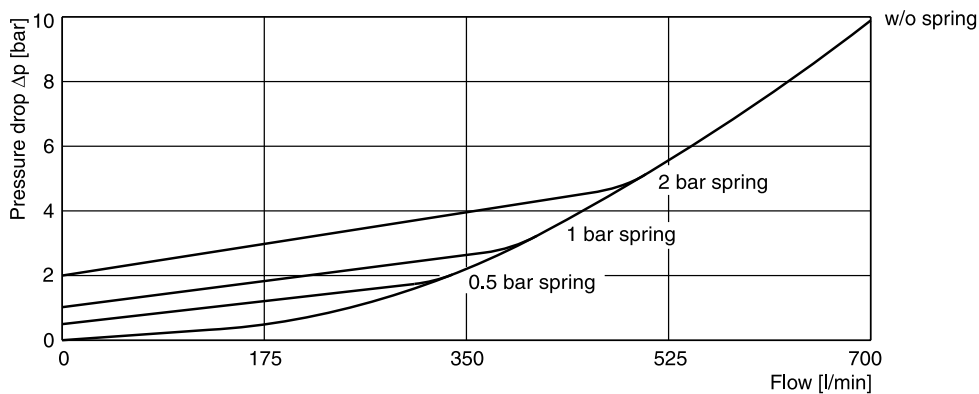

All characteristic curves measured with HLP46 at 50 °C.

Dimensions

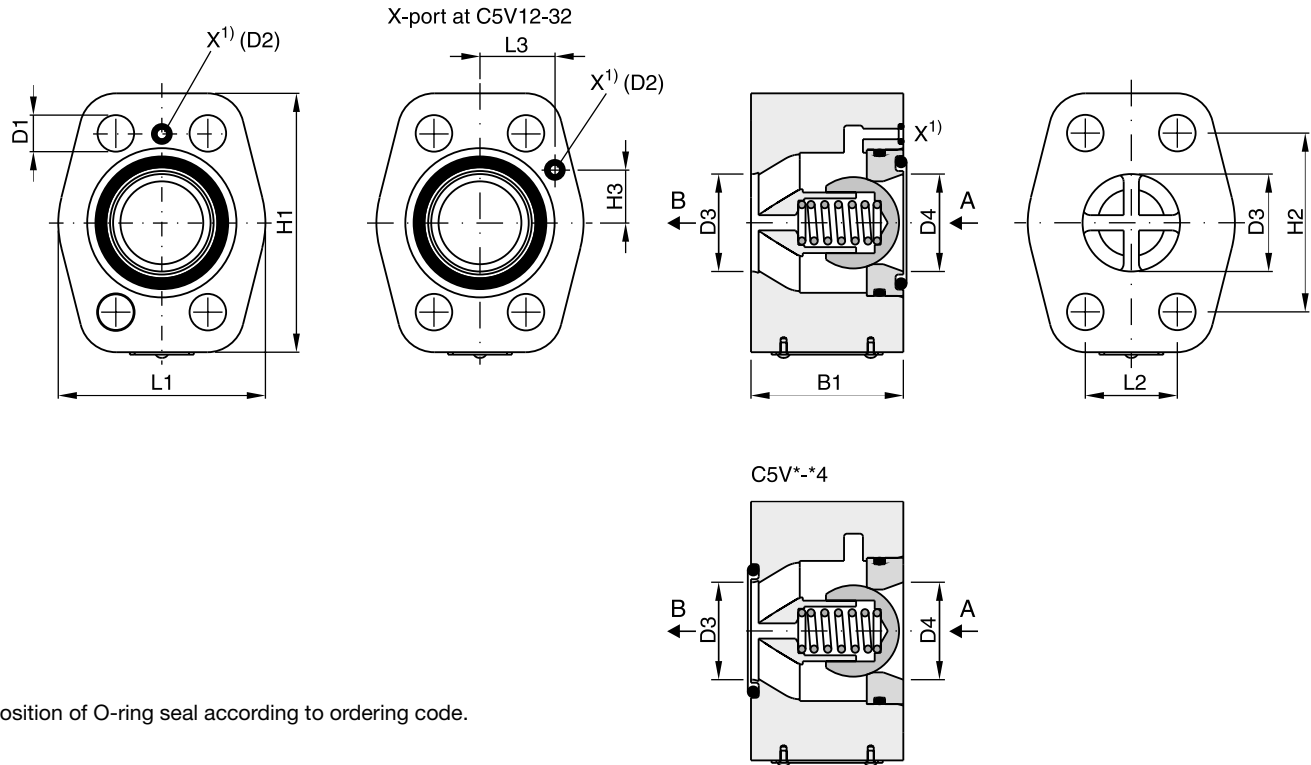

Position of O-ring seal according to ordering code.

9

Seal kits		
NG	NBR	FPM
06	S26-75409-0	S26-75409-5
08	S26-75410-0	S26-75410-5
10	S26-75411-0	S26-75411-5
12	S26-75412-0	S26-75412-5

Series	Nominal Size	L1	L2	L3	H1	H2	H3	B1	D1	D2	D3 + 0.8	D4	
C5V06	3/4"	SAE61	48	22.2	-	64	47.6	-	45	10.5	Ø3	19	19
		SAE62	48	23.8	-	64	50.8	-	45	10.5	-	19	19
C5V08	1"	SAE61	60	26.2	-	74	52.4	-	45	10.5	Ø3	25	25
		SAE62	60	27.8	-	74	57.2	-	45	12.5	-	25	25
C5V10	1 1/4"	SAE61	68	30.2	-	85	58.7	-	50	12.5	Ø3	32	32
		SAE62	68	31.8	-	85	66.7	-	50	13.5 ²⁾	-	32	32
C5V12	1 1/2"	SAE61	80	35.7	27.2	104	69.8	22.4	50	13.5	Ø3	42	38
		SAE62	80	36.5	27.2	104	79.4	22.4	50	17	-	42	38

¹⁾ X1 port for C5V*32* (for use with unloading valve R5U).

²⁾ D1 = 15 at option code 019 for M14 mounting screws.