

Characteristics

Pilot Operated Proportional Reducing Valve Series VMY

Proportional pressure reducing valves of the series VMY allow the variable adjustment of the reduced pressure from 0 bar up to the nominal pressure.

The valve consists of a spool type main stage and a proportionally operated pilot stage. The desired pressure can be variably set corresponding to the command signal specified on the amplifier. The proportional solenoid converts the current of the amplifier into force on the valve poppet of the pilot stage.

Typical applications are pressure systems, test equipment, or counterweight systems. The optimum performance can be achieved in combination with the digital amplifier module PCD00A-400 for open loop systems or with PWDXXA-40* for closed loop systems.

Function VMY*K06

With the proportional solenoids de-energized the main spring forces the main spool into the neutral position. Port A is connected to port T. Thus the reduced pressure only depends on the back pressure in the external drain pipe and/or the tank pressure and can accordingly be reduced down to 0 bar. The pressure present in the P line delivers the pilot oil to the pilot stage via a flow control valve.

When the proportional solenoid is energized, the pilot pressure is increased in the pilot pressure area, and the main spool moves against the spring until the connection P - A opens. The regulation of the reduced pressure on connection A takes place by the constant comparison of the actual pressure and the reference pressure of the pilot stage.



VMY*K06

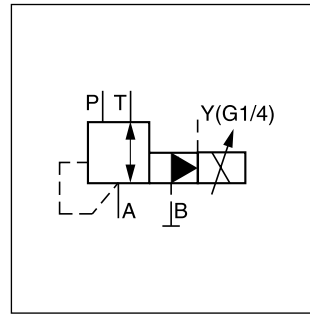

VMY*K06

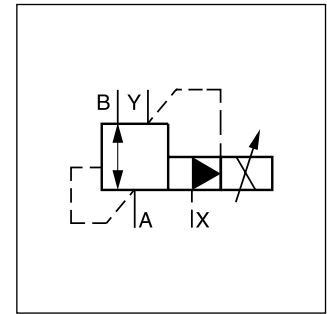

VMY*K10

VMY*K10

The valve spool is designed so that the connection B-A is open in the neutral position and is closed in the working position.

VMY*K06N

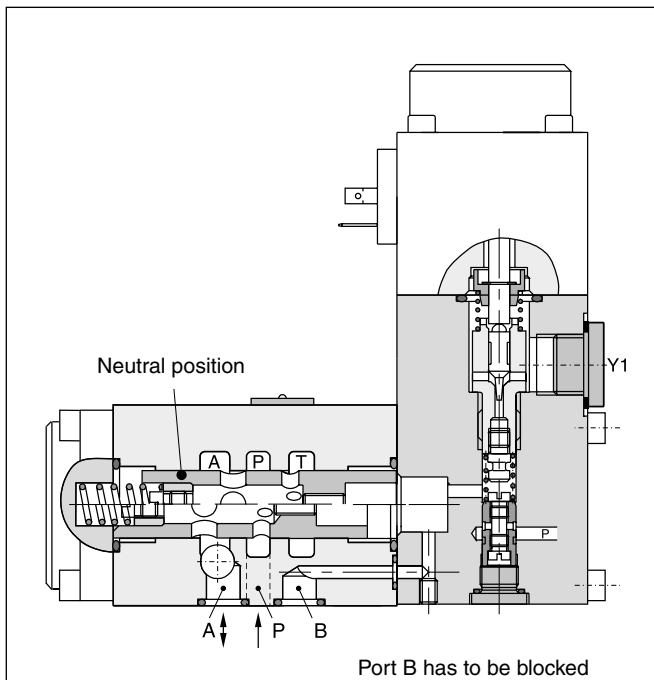

VMY*K10

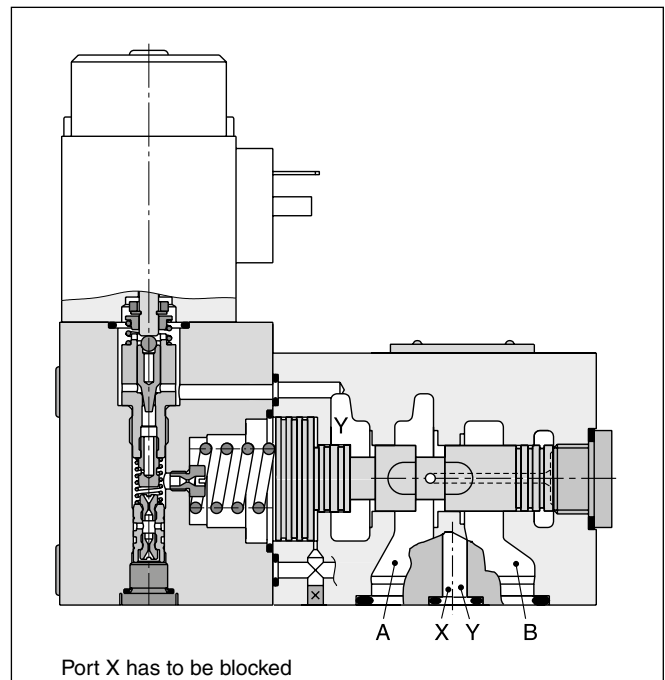

Ordering Code / Technical Data

Ordering code

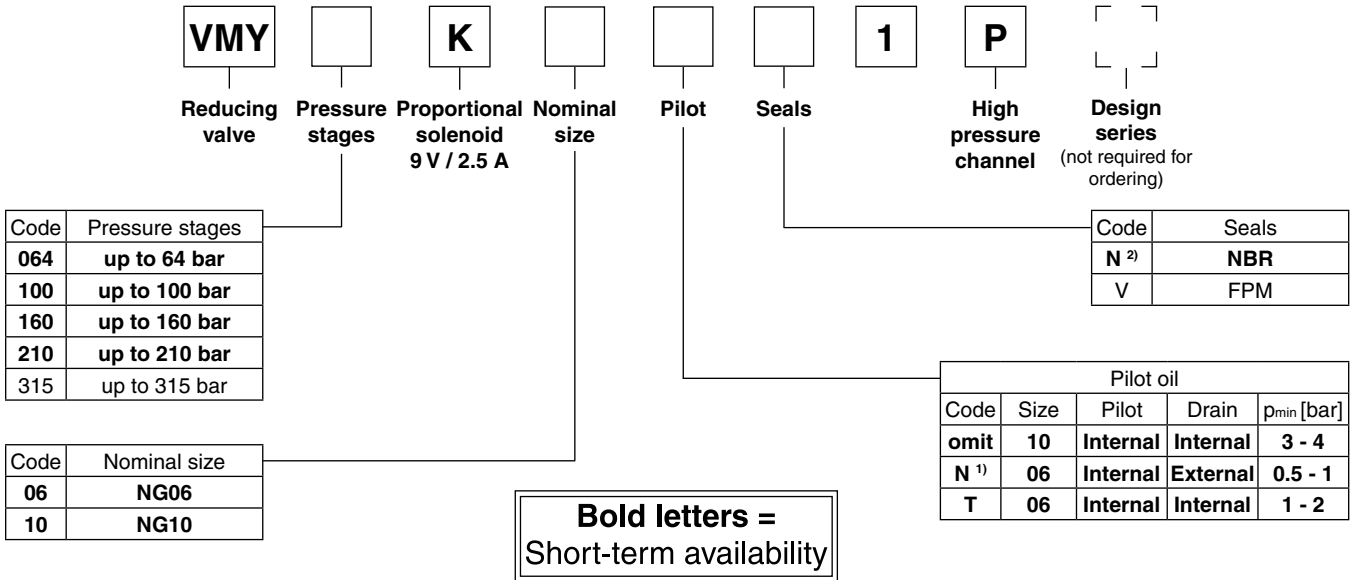

Technical data

General				
Design	3 way proportional reducing valve, pilot operated, spool design			
Nominal size	06 (DIN NG06/CETOP 03/NFPA D03)		10 (DIN NG10/CETOP 05/NFPA D05)	
Interface	Subplate mounting according to ISO 5781			
Actuation	Proportional solenoid			
Mounting position	unrestricted			
Ambient temperature	[°C]	-20 ... +60		
MTTF _D value	[years]	75		
Weight	[kg]	2.8	5	
Hydraulics				
Max. operating pressure	[bar]	Size 06: Ports P, A 315; Port T, Y depressurized; port B has to be blocked		
	[bar]	Size 10: Ports A, B 350; Port Y depressurized; port X has to be blocked		
Pressure stages	[bar]	64, 100, 160, 210, 315		
Nominal flow	[l/min]	40	160	
Fluid	Hydraulic oil according to DIN 51524			
Viscosity	permitted [cSt] / recommended [cSt]	[mm ² /s]	20 ... 400 / 30 ... 80	
Fluid temperature	[°C]	-20...+70 (NBR: -25...+70)		
Filtration	ISO 4406 (1999); 18/16/13			
Linearity	[%]	See characteristic pressure curves	±3.5 at > 15 % p _{nom}	
Repeatability	[%]	<±2		
Hysteresis	[%]	<3		
Response time	[ms]	<150	<200	
Electrical				
Duty ratio	[%]	100 ED		
Protection class	IP65 in accordance with EN 60529 (with correctly mounted plug-in connector)			
Nominal voltage	[VDC]	9		
Max. current	[A]	2.7		
Nom. current	[A]	2.5		
Ambient temperature	[°C]	-20...+70		
Coil resistance	[Ohm]	-2.1 (at 20 °C)		
Solenoid connection	Connector as per EN 175301-803			
Power amplifier, recommended	PCD00A-400			

¹⁾ Connection on port Y1 or Y2.
²⁾ Not for NG06.

NG06 Characteristic pressure lines $p = f(U_{set})$

Setting range max. 64 bar

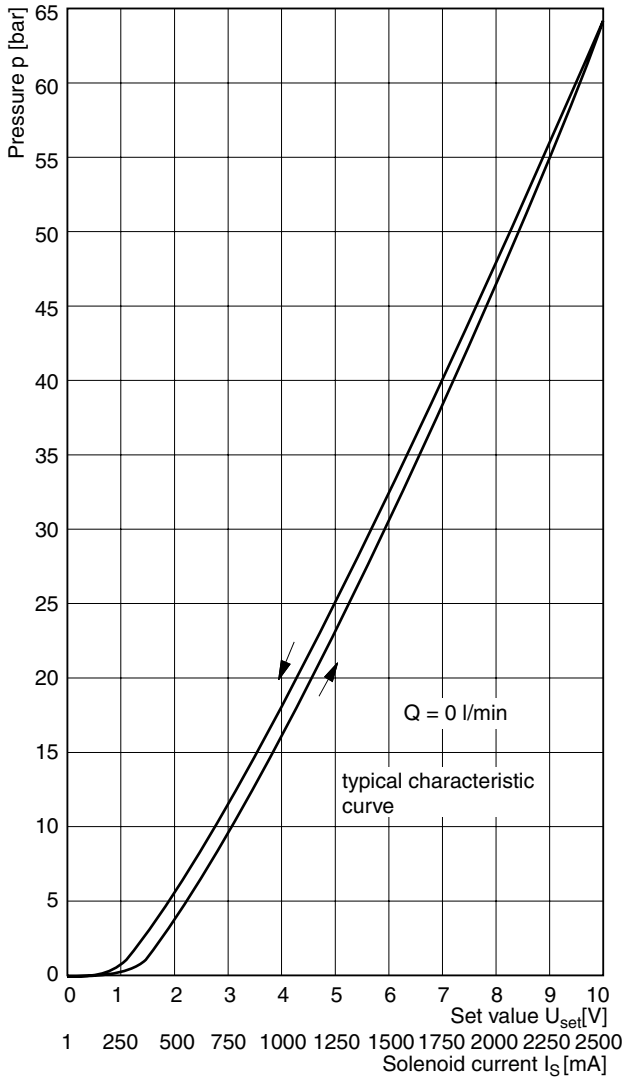

Setting range max. 210 bar

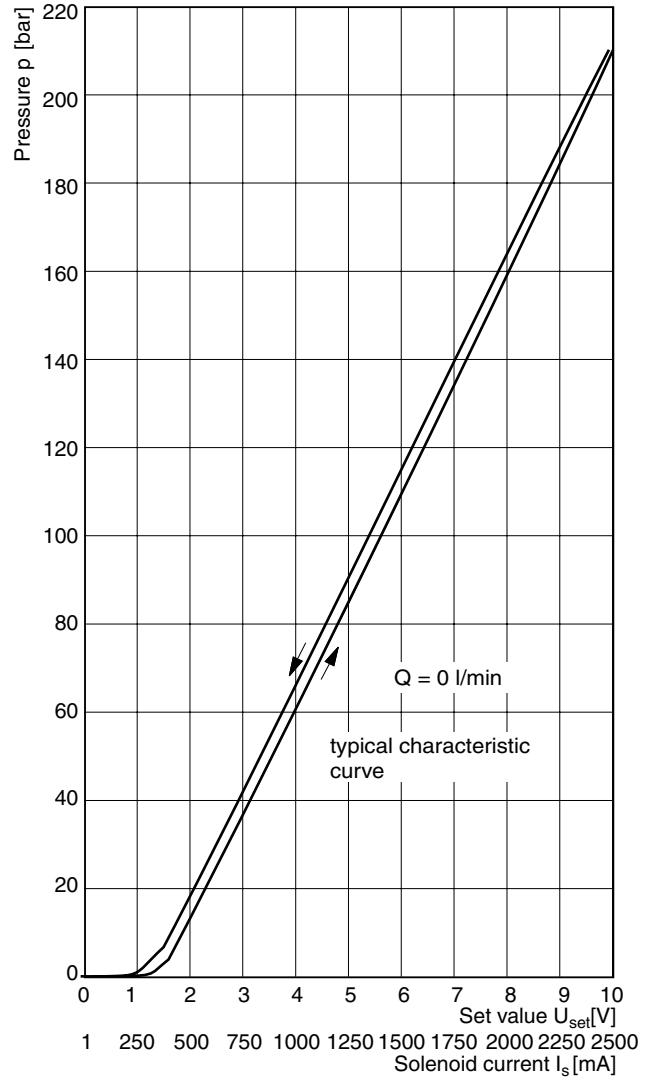

NG06 p/Q characteristics

Setting range max. 64 bar

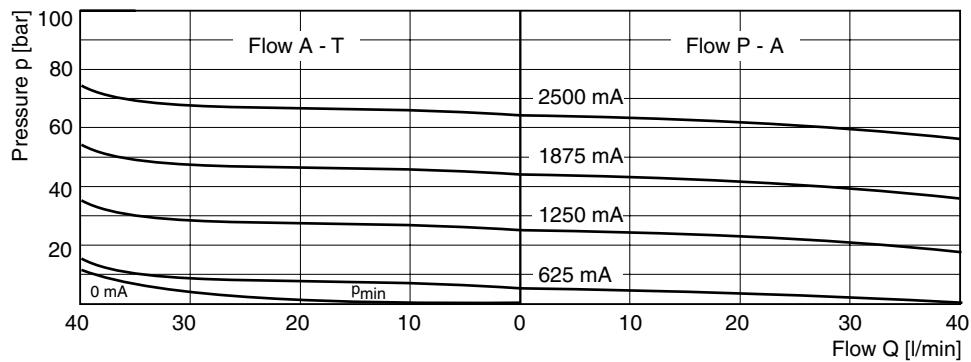

All characteristic curves measured with HLP46 at 50 °C.

NG06 p/Q characteristics

Setting range max. 100 bar

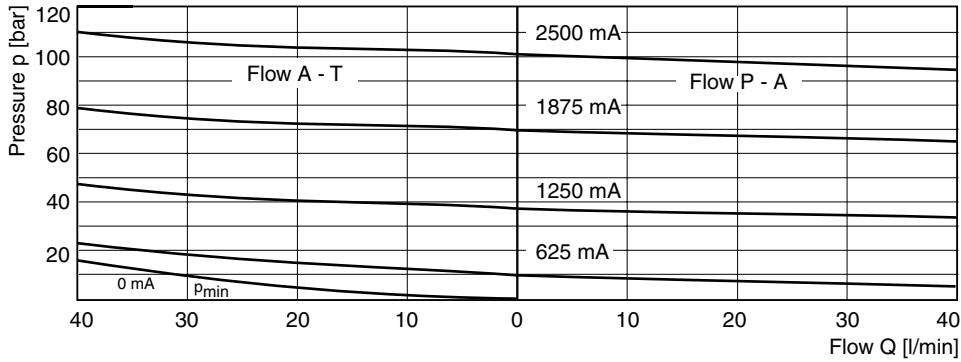

Setting range max. 160 bar

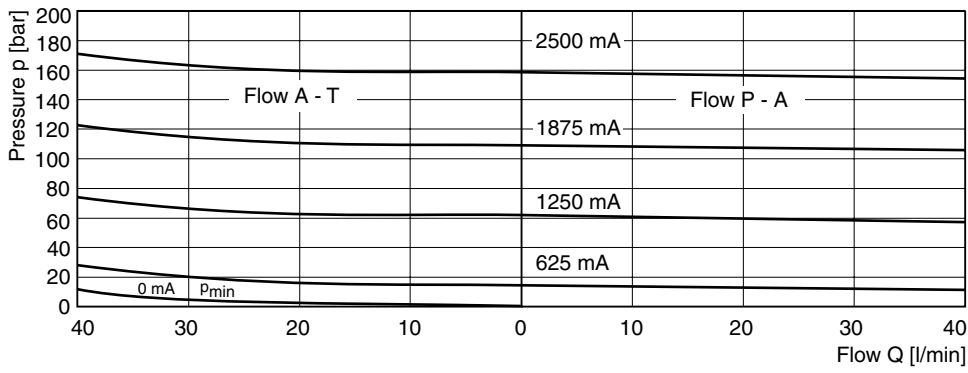

Setting range max. 210 bar

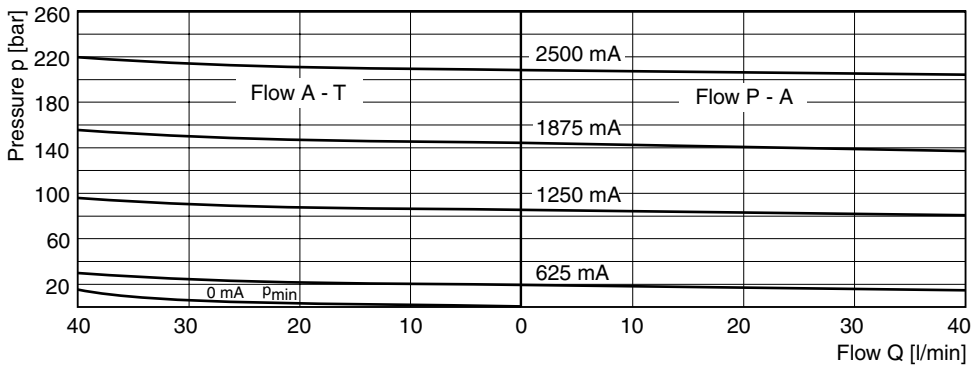

Setting range max. 315 bar

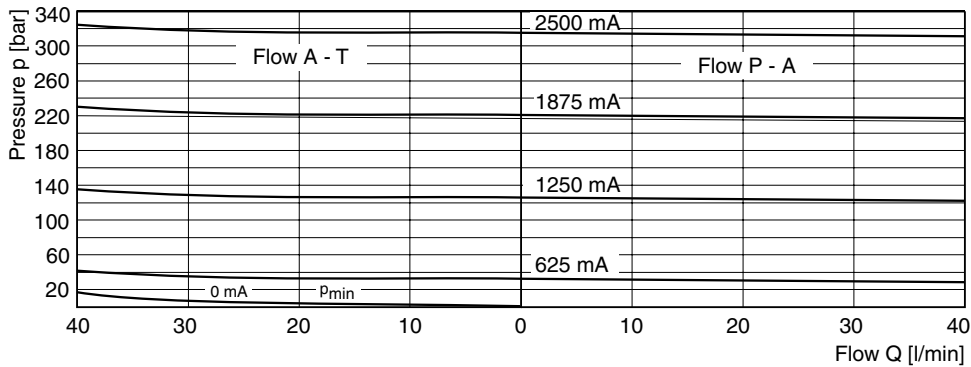

All characteristic curves measured with HLP46 at 50 °C.

Step response

Typical curve

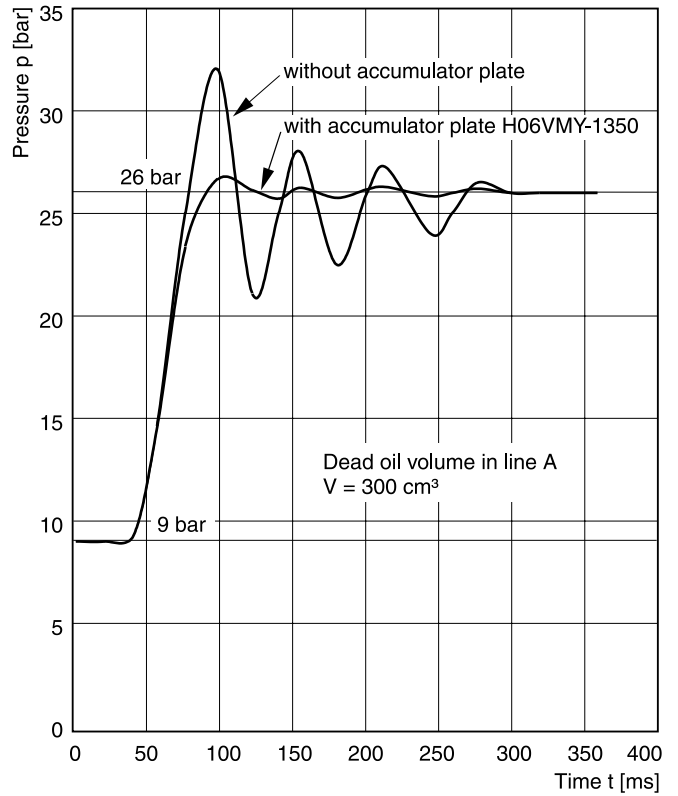
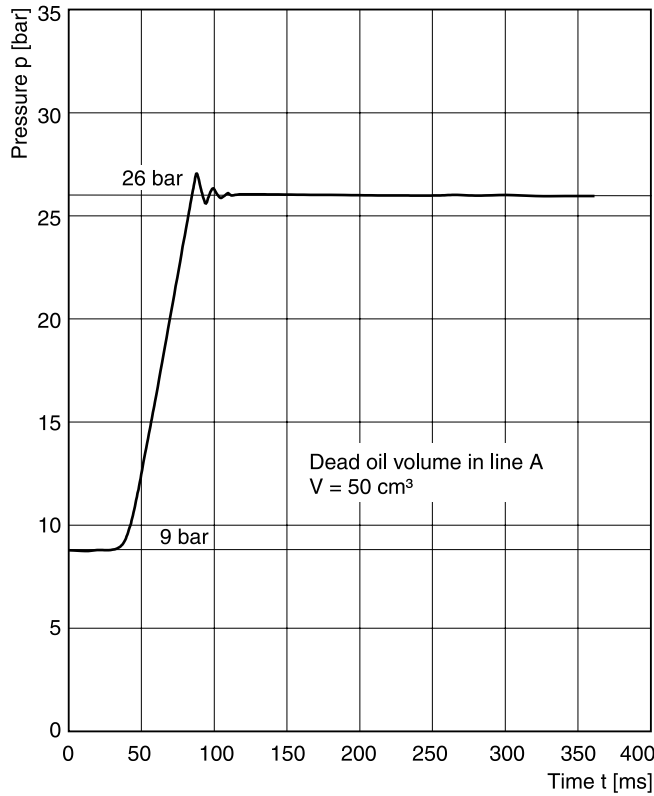

All characteristic curves measured with HLP46 at 50 °C.

Accumulator plate H06VMY-1350

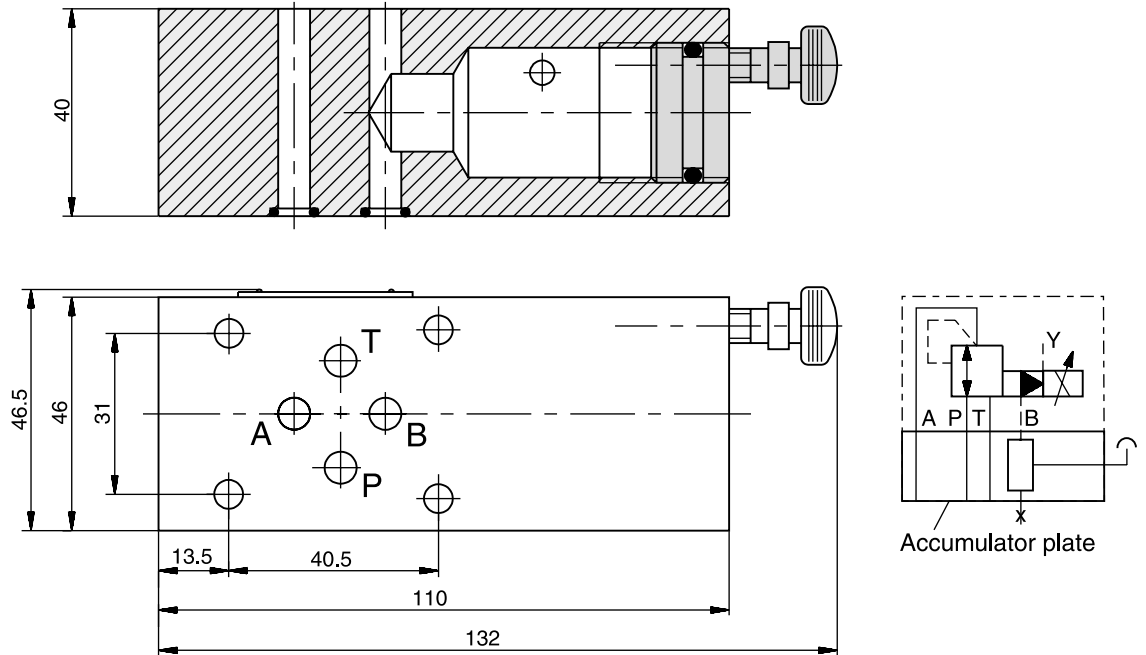

NG10 p/Q characteristics
 for pilot oil supply from high pressure channel P

Setting range max. 64 bar

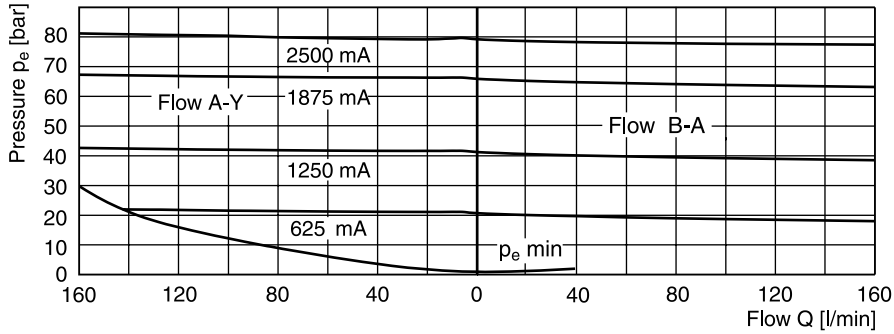

Setting range max. 100 bar

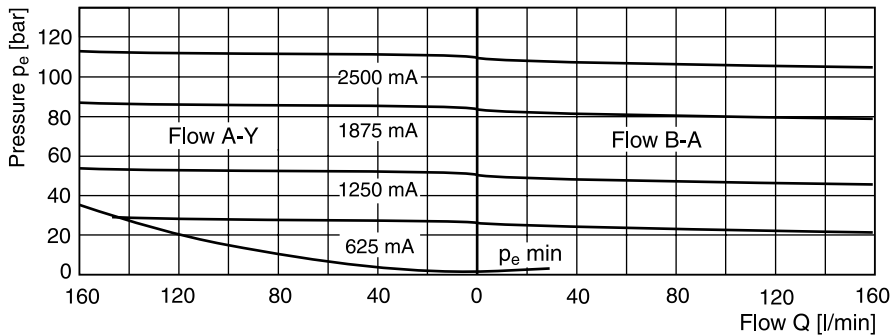

Setting range max. 160 bar

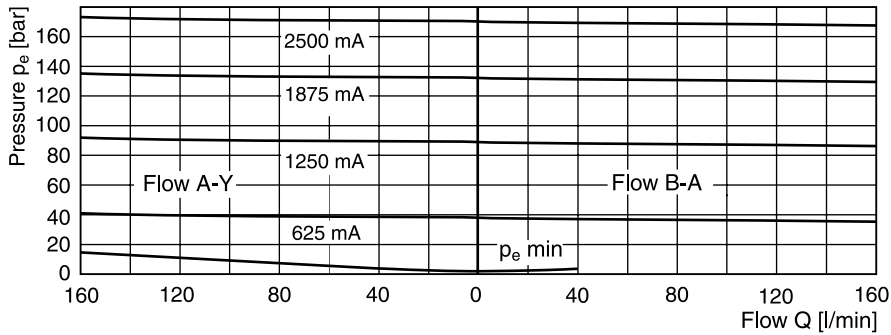

Setting range max. 210 bar

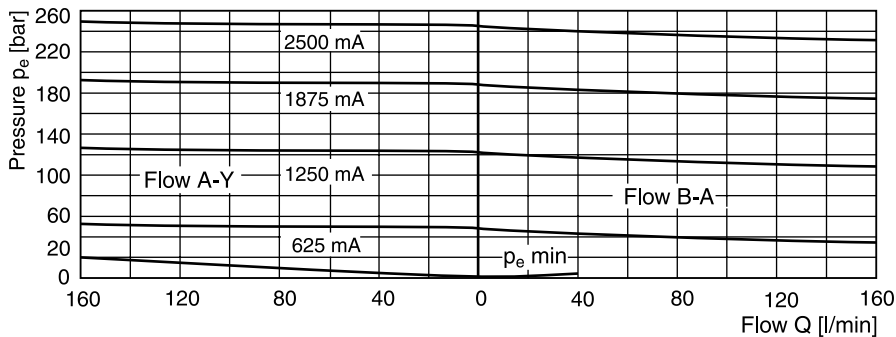

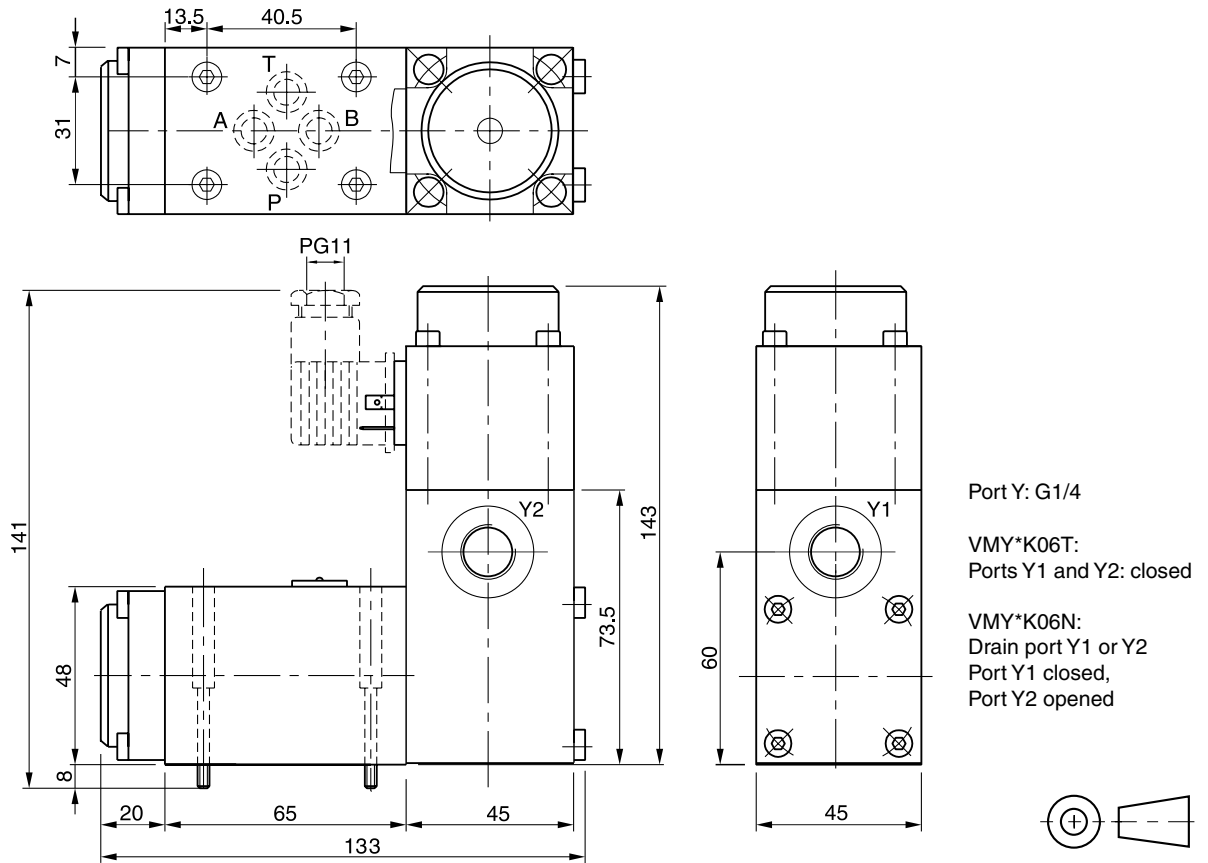

All characteristic curves measured with HLP46 at 50 °C.

NG06

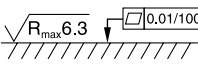

4

Surface finish	Bolt kit			 Kit FPM
	BK375	4x M5x30 ISO 4762-12.9	7.6 Nm ±15 %	SK-VMY-L06-V

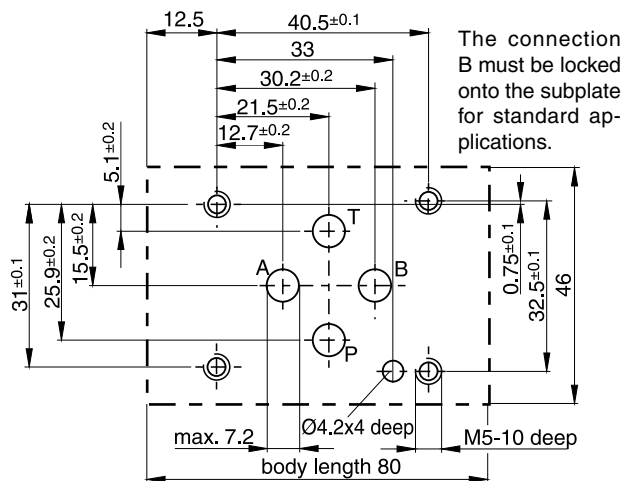

Mounting pattern ISO 5781-03-04-0-00

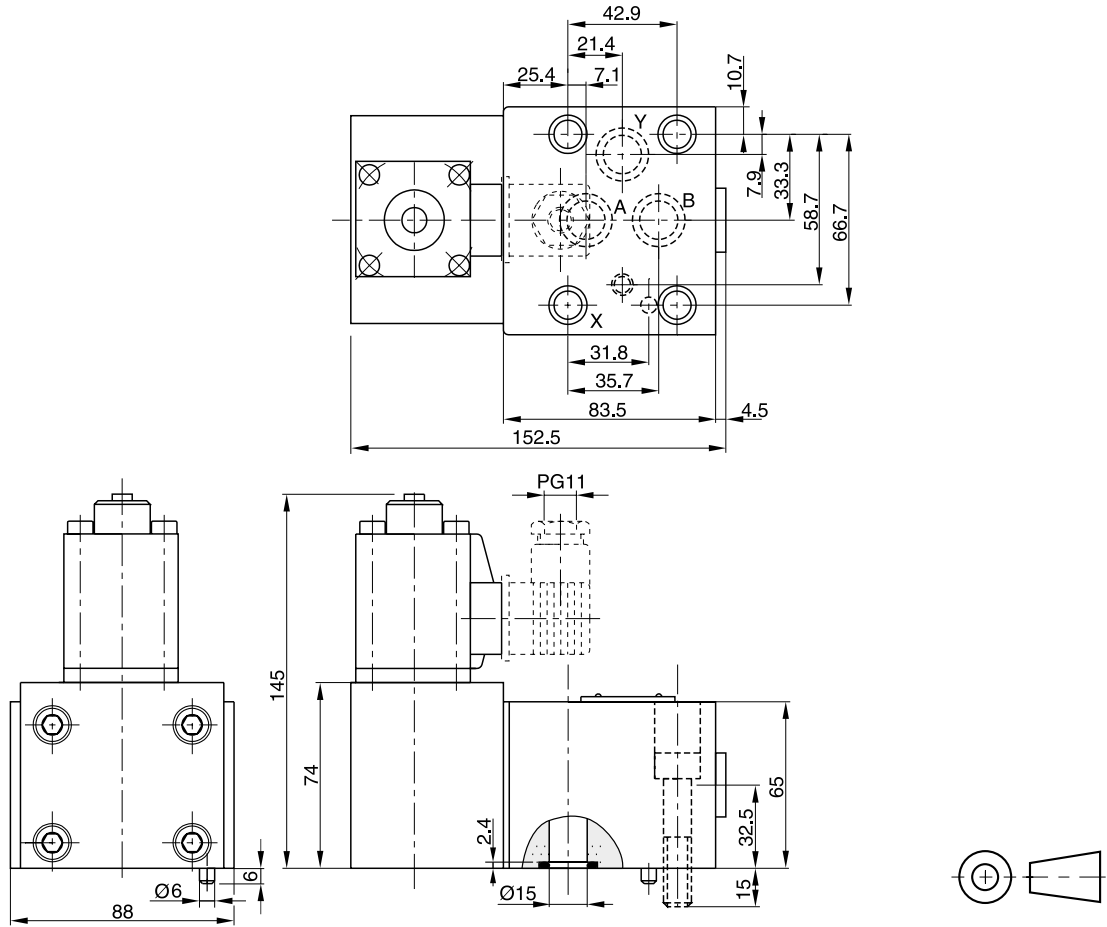

NG10

4

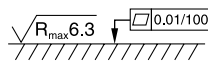

Surface finish	Bolt kit			 Kit FPM
	BK389	4x M10x50 ISO 4762-12.9	63 Nm ±15 %	SK-VB/VM-A10V

Mounting pattern ISO 5781-06-07-0-00 ¹⁾

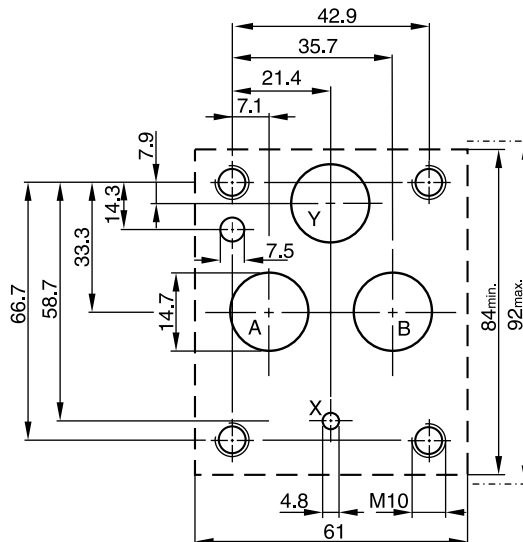

¹⁾ Deviating from ISO the Y port has Ø 14.7 instead of Ø 4.8.